

VENEZIANA

STANDARD

15 MM - 25 MM

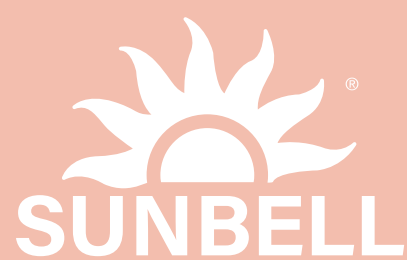

STANDARD 15 MM - 25 MM

CARATTERISTICHE TECNICHE

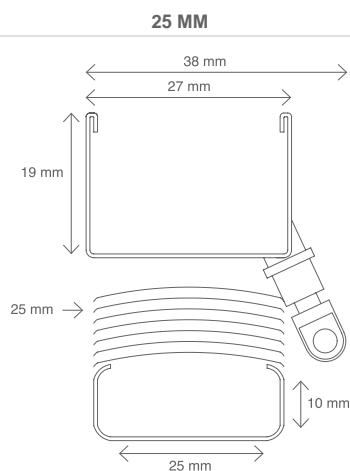
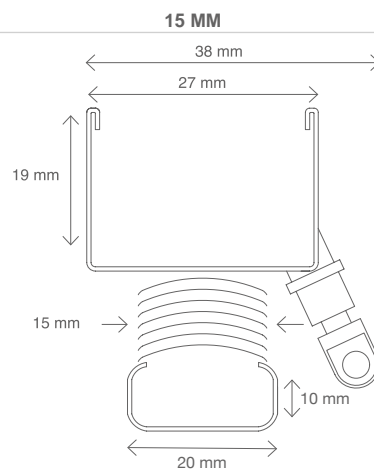
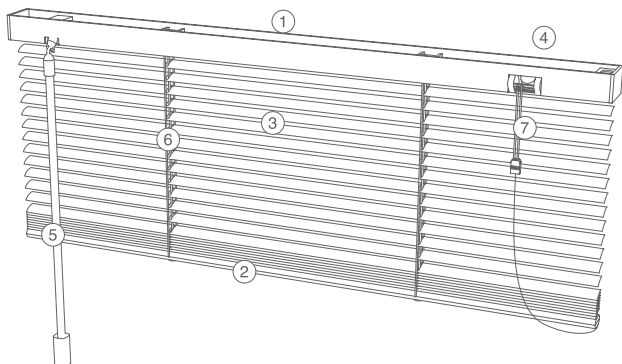

* L'ingombro del cassonetto più l'orientatore è pari a circa 38 mm (vedi disegni).

1. Profilo superiore in acciaio inox, rullato a freddo e laccato, di dimensioni 27 x 19 mm, di spessore 0,5 mm e disponibile con abbinamento tinte delle lamelle come da campionario.

2. Il fondale inferiore in acciaio inox, rullato a freddo, di dimensioni 25 x 10 mm in abbinamento a lamella da 25 mm e dimensioni 20 x 10 mm in abbinamento a lamella da 15 mm; (per la disponibilità fondale 20 x 10 mm vedi tabella abbinamenti a pagina 13 del presente listino), il suo spessore è di 0,5 mm. Tale profilo è disponibile in abbinamento tinte colori con profilo superiore.

5. Il movimento di orientamento si effettua con asta in poliuretano con innesto a gancio*.

6. Scaletta e corda in terilene 100% poliestere multifilo termofissato ad alta resistenza alla rottura e allungamento con trattamento anti raggi UV. Fornita con sfumature in tinta con colori lamelle, la scaletta ha passo 13 mm per veneziana 15 mm (77 lamelle al m lineare) e passo 22 mm per veneziana 25 mm (47 lamelle al m lineare).

3. Lamella 15/25 mm: in speciale lega di alluminio manganese spessore 0,21 - 0,18 mm, resistente alla corrosione, temprata, pretrattata e verniciata a caldo con vernici senza piombo al fine di garantire durata e luminosità in una vasta gamma di colori disponibili.

4. Il movimento di impacchettamento avviene tramite un fermacorda a rullo dentato con separatore a pettine, fino a un massimo di 4 corde.

7. Connettore munito di separatore corde utili per impacchettamento.

N.B. Il modello Veneziana 15 mm - 25 mm può essere realizzato anche in forma trapezoidale.

RILIEVO MISURE

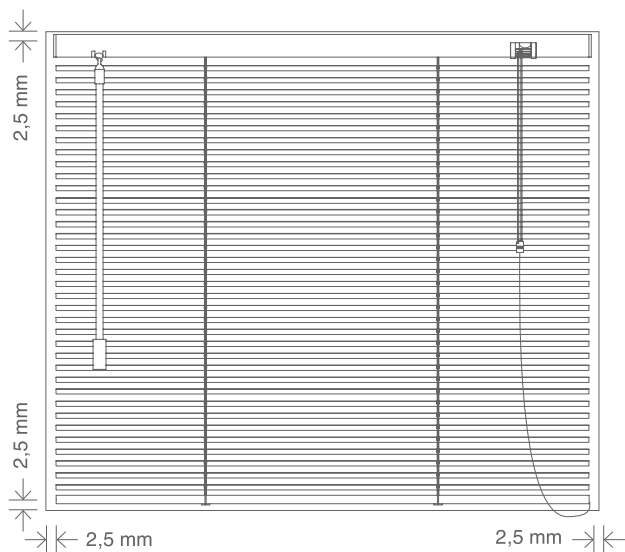

A. se indicata "misura luce" verranno tolti in fase di produzione 5 mm in larghezza e in altezza.

B. se indicata "misura finita" le misure verranno mantenute come da ordine.

In caso di diverse necessità, contattare l'ufficio commerciale.

ACCESSORI DI FISSAGGIO

SUPPORTI

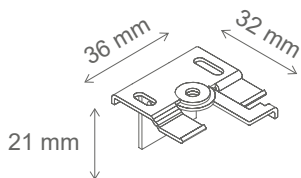

SUPPORTO UNIVERSALE
(soffitto e/o parete fornito di serie)

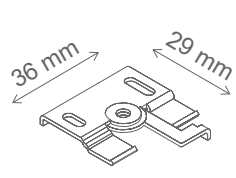

SUPPORTO A SOFFITTO
(a richiesta)

N.B. L'ingombro totale del supporto è pari a 50 mm.

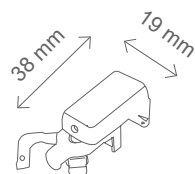

SUPPORTO AD AGGANCIAMENTO
NO FORO DISPONIBILE NEI COLORI:
BIANCO, GRIGIO, NERO
(a richiesta)

N.B. Indicare la scelta desiderata nel modulo d'ordine.

GUIDE FONDALE

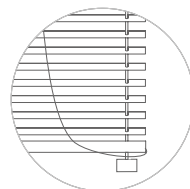

FONDALE LUNGO

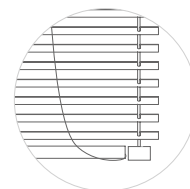

FONDALE CORTO

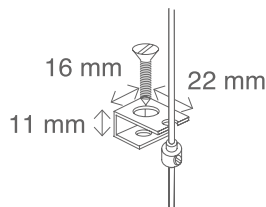

SQUADRETTA / PARETE

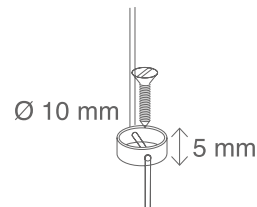

TENDICAVO / PIANO

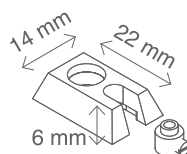

SQUADRETTA IN
POLICARBONATO
CON TENDICAVO

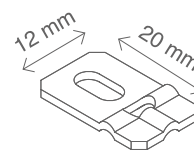

PIASTRINA
TENDICAVO

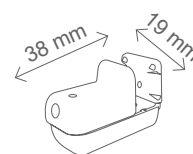

SUPPORTO TENDICAVO
NO FORO
DISPONIBILE NEI COLORI:
BIANCO, GRIGIO, NERO
(a richiesta)

STANDARD 15 MM - 25 MM

INGOMBRI DI SISTEMA

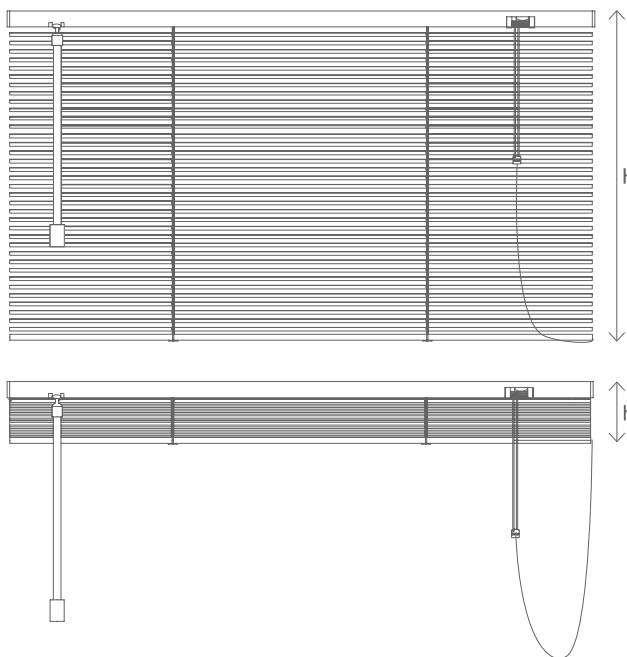

LAMELLE *	H mm	1000	1500	2000	2500
15 mm	h mm	65	80	90	105
25 mm	h mm	59	71	82	93

*Ingombri indicativi

SUPPORTI

Larghezza mm	< 1000	< 1800	< 2400	OLTRE
N° supporti	2	3	4	5

DIMENSIONE ASTA DI ORIENTAMENTO

Altezza veneziana in mm	Altezza asta in mm
da 0 a 850	500
da 860 a 1100	750
da 1110 a 1350	1000
da 1360 a 1600	1250
da 1610 a 3000	1500
da 3010 a 3500	2000

TIPI DI COMANDI

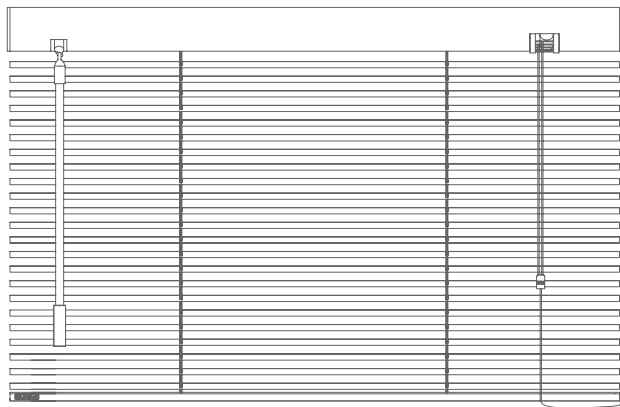

COMANDI E FATTIBILITÀ

Da larghezza	A larghezza	Tipo di comando
150 mm	210 mm	Solo orientamento
211 mm	231 mm	Comandi standard
232 mm	3000 mm	Comandi standard / raggruppati







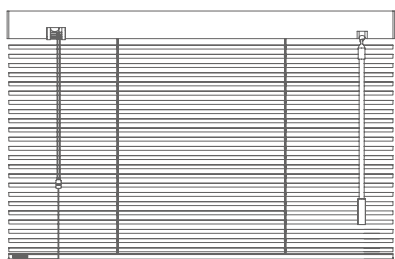
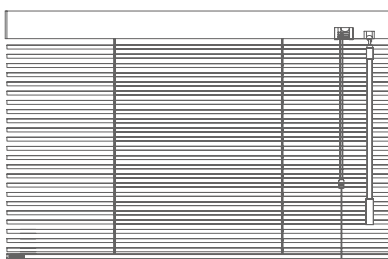
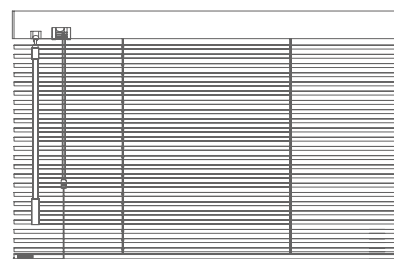



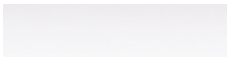













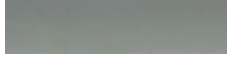



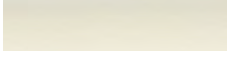

N.B. Misura massima in larghezza e altezza 3000 mm.

Fornitura standard

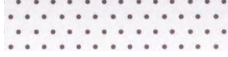
COMANDI ASTA A SINISTRA CORDA A DESTRA











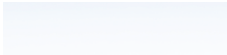
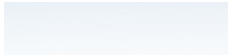
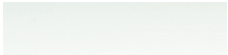

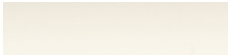











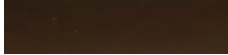



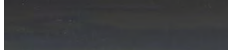

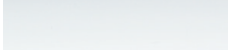

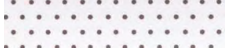

Su richiesta
COMANDI ASTA A DESTRA CORDA
A SINISTRASu richiesta
COMANDI A DESTRASu richiesta
COMANDI A SINISTRA

CARTELLA COLORI - 15 MM

				
001	002	011	015	018
				
019	027	048	057	034
				
035	043	044	045	046
				
056	049	050	051	052
				
053	029	028	070	087
				
195	199	200	239	240
				
235	399	144		

N.B. Per la scelta del colore desiderato consultare l'apposita CARTELLA COLORI.

CARTELLA COLORI - 25 mm

				
001	002	003	028	070
				
011	012	014	015	018
				
019	021	027	004	029
				
030	034	035	040	043
				
044	045	047	050	005
				
046	049	057	061	048
				
087	199	200	233	235
				
239	240	286	399	144

N.B. Per la scelta del colore desiderato consultare l'apposita CARTELLA COLORI.

VENEZIANA

IN LAMIERA

35 MM
50 MM

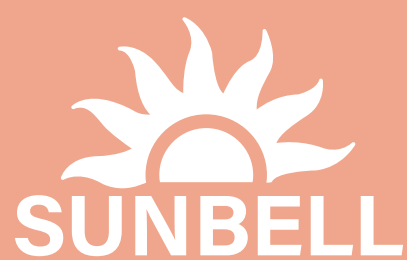

VENEZIANA 35 MM IN LAMIERA

CARATTERISTICHE TECNICHE

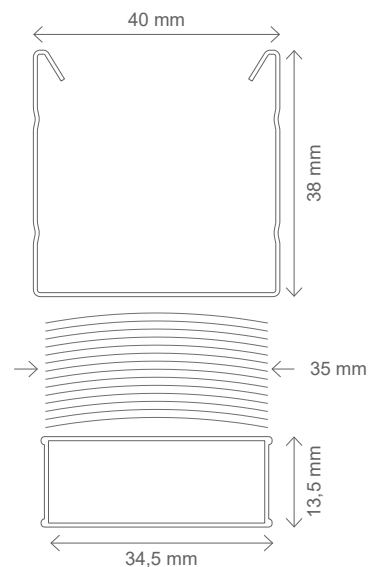
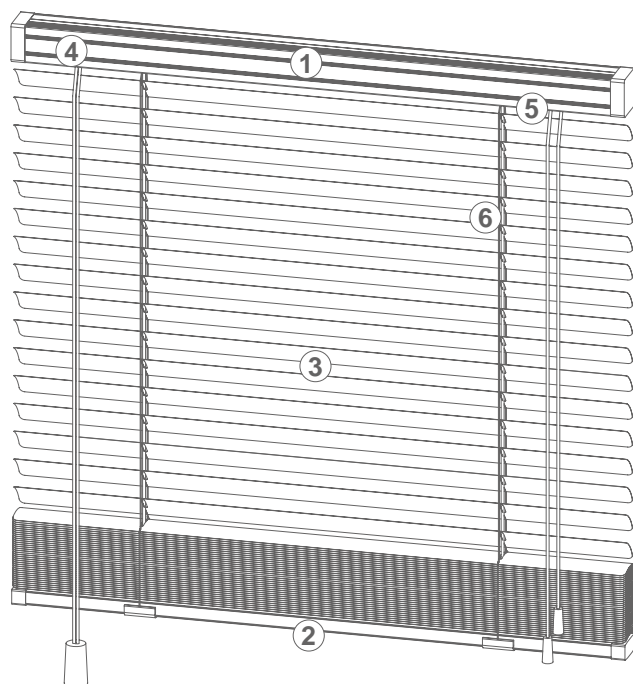

1. Profilo superiore
in acciaio zincato misura 40x38 mm, spessore 0,6 mm, verniciato in abbinamento alle tinte delle lamelle, come da campionario.
Fornito con tappi laterali di chiusura in materiale plastico.

2. Fondale inferiore in acciaio zincato, misura 34,5x13,5 mm, spessore 0,6 mm, verniciato in abbinamento alle tinte delle lamelle, come da campionario.
Fornito con tappi laterali di chiusura in materiale plastico.

3. Lamella 35 mm in speciale lega di alluminio-manganese spessore 0,23 mm, resistente alla corrosione, temprata, pretrattata e verniciata a caldo con vernici senza piombo al fine di garantire durata e luminosità.
Colori disponibili come da campionario.

4. Fermacorda con rullo dentato per il movimento di impacchettamento, ospita fino a un massimo di 4 corde.

5. Orientatore a corda per gestire l'inclinazione delle lamelle.

6. Scaletta e corda in terilene 100% poliestere multifilo termofissato ad alta resistenza alla rottura e allungamento con trattamento anti raggi UV.
Fornita con sfumature in tinta con i colori delle lamelle, la scaletta ha passo 28 mm (36 lamelle al m lineare).

N.B. Conforme alla marcatura CE per installazioni all'esterno.

VENEZIANA 35 MM IN LAMIERA

RILIEVO MISURE

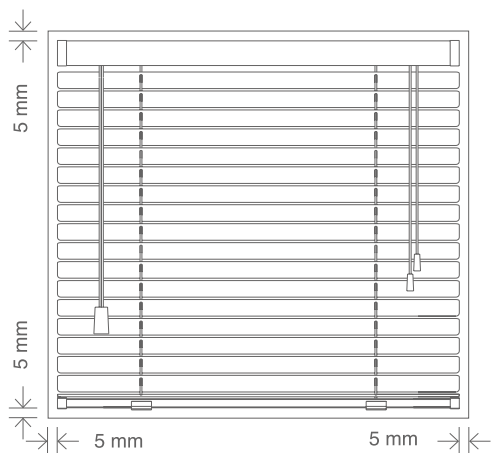

A. Se indicata "misura luce" verranno tolti in fase di produzione 10 mm in larghezza e in altezza.

B. Se indicata "misura finita" le misure verranno mantenute come da ordine.

In caso di diverse necessità, contattare l'ufficio commerciale.

ACCESSORI DI FISSAGGIO

SUPPORTI

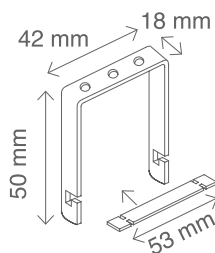

CAVALLOTTO SUPPORTO A SOFFITTO (fornito di serie)

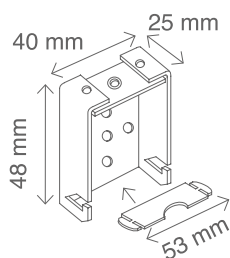

SCATOLA PER FISSAGGIO A PARETE O SOFFITTO (a richiesta)

N.B. Indicare la scelta desiderata nel modulo d'ordine.

GUIDE FONDALE

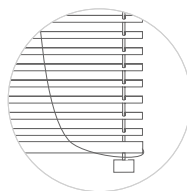

FONDALE LUNGO

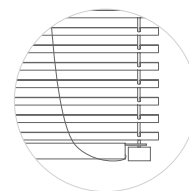

FONDALE CORTO

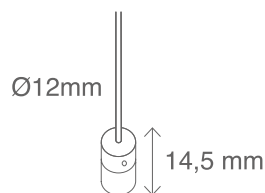

MORSETTONE IN ACCIAIO ZINCATO (fornito di serie)

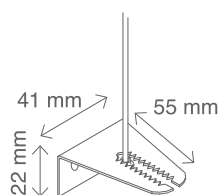

SQUADRETTA DI FISSAGGIO A PARETE CON MORSETTO (a richiesta)

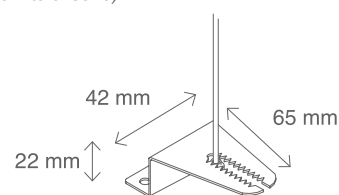

SQUADRETTA A Z CON MORSETTO (a richiesta)

INGOMBRI DI SISTEMA

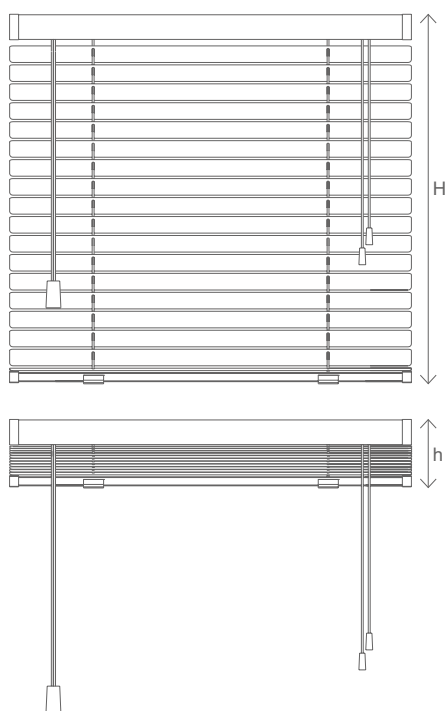

INGOMBRI *			
H mm	1500	2000	2500
h mm	85	115	145

*Ingombri indicativi

SUPPORTI			
Larghezza mm	< 1000	< 2400	OLTRE
N° supporti	2	3	4

TIPI DI COMANDI

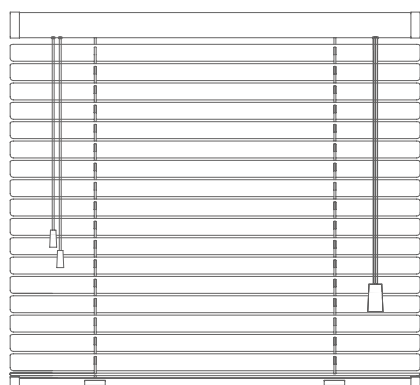

COMANDI E FATTIBILITÀ		
Da larghezza	A larghezza	Tipo di comando
240 mm	350 mm	Comandi standard
351 mm	3000 mm	Comandi standard / raggruppati

N.B. Misura massima in larghezza e altezza 3000 mm.

Fornitura standard

IMPACCHETTAMENTO A DESTRA, ORIENTAMENTO A SINISTRA



Su richiesta
IMPACCHETTAMENTO A SINISTRA, ORIENTAMENTO A DESTRA

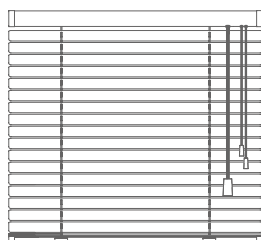

Su richiesta
COMANDI A DESTRA

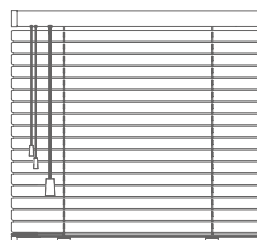

Su richiesta
COMANDI A SINISTRA

CARTELLA COLORI - 35 MM

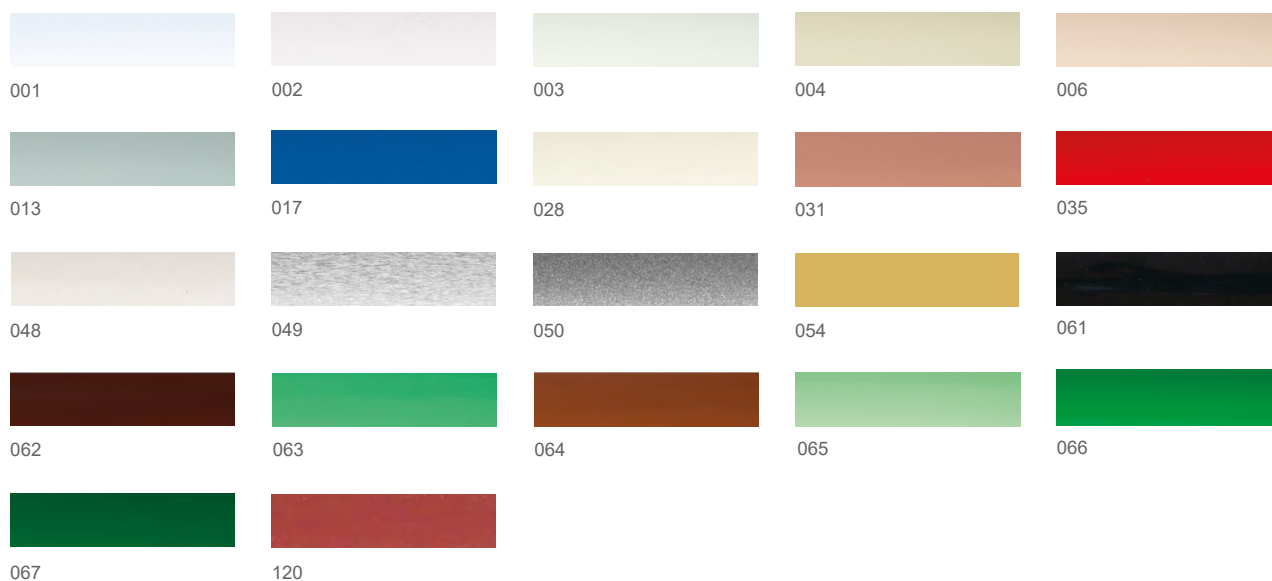

N.B. Per la scelta del colore desiderato consultare l'apposita CARTELLA COLORI.

ENEZIA 50 MM IN LAMIERA

CARATTERISTICHE TECNICHE

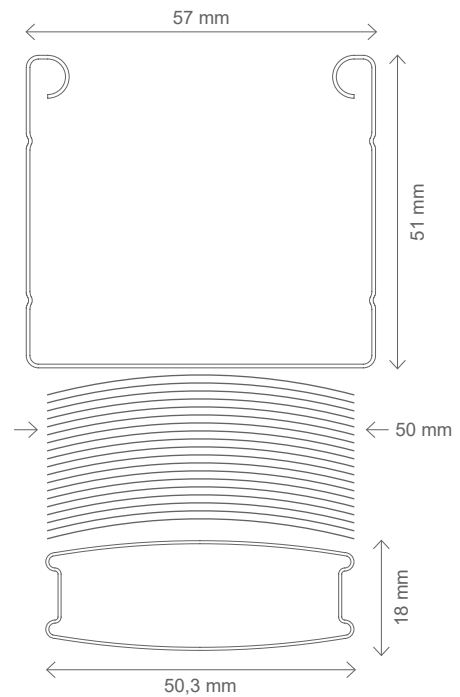
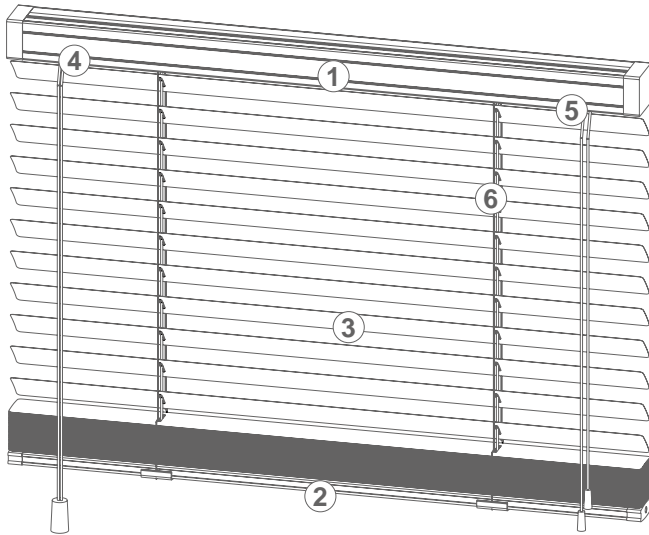

1. Profilo superiore in acciaio zincato misura 57x51 mm, spessore 0,6 mm, verniciato in abbinamento alle tinte delle lamelle, come da campionario. Fornito con tappi laterali di chiusura in materiale plastico.

2. Fondale inferiore in acciaio zincato, misura 50,3x18 mm, spessore 0,6 mm, verniciato in abbinamento alle tinte delle lamelle, come da campionario. Fornito con tappi laterali di chiusura in materiale plastico.

3. Lamella 50 mm in speciale lega di alluminio-manganese spessore 0,23 mm, resistente alla corrosione, temprata, pretrattata e verniciata a caldo con vernici senza piombo al fine di garantire durata e luminosità. Colori disponibili come da campionario.

4. Fermacorda con rullo dentato per il movimento di impacchettamento, ospita fino a un massimo di 4 corde.

5. Orientatore a corda per gestire l'inclinazione delle lamelle.

6. Scaletta e corda in terilene 100% poliestere multifilo termofissato ad alta resistenza alla rottura e allungamento con trattamento anti raggi UV. Fornita con sfumature in tinta con i colori delle lamelle, la scaletta ha passo 42 mm (24 lamelle al m lineare).

N.B. Conforme alla marcatura CE per installazioni all'esterno.

RILIEVO MISURE

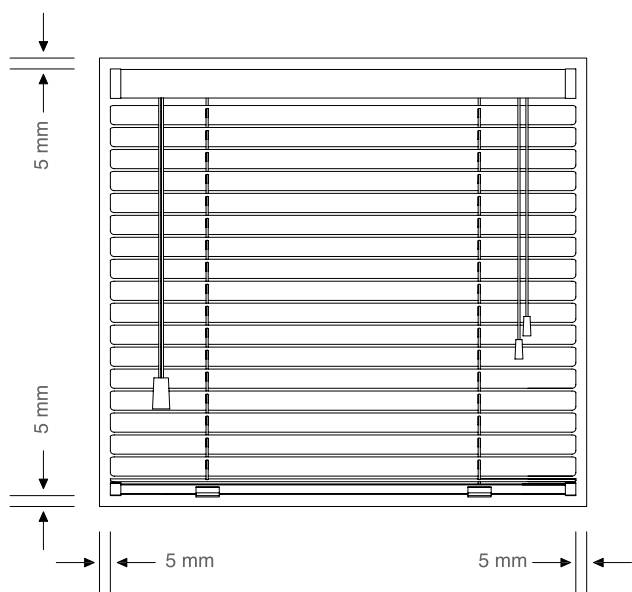

A. Se indicata "misura luce" verranno tolti in fase di produzione 10 mm in larghezza e in altezza.

B. Se indicata "misura finita" le misure verranno mantenute come da ordine.

In caso di diverse necessità, contattare l'ufficio commerciale.

ACCESSORI DI FISSAGGIO

SUPPORTI

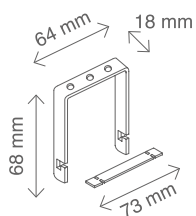

CAVALLOTTO A SOFFITTO (fornito di serie)

GUIDE FONDALE

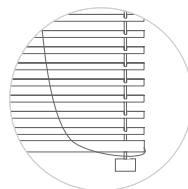

FONDALE LUNGO

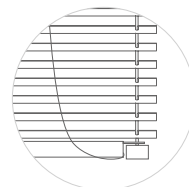

FONDALE CORTO

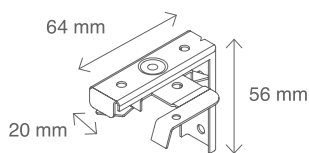

SUPPORTO A SCOMPARSA A SOFFITTO (a richiesta)

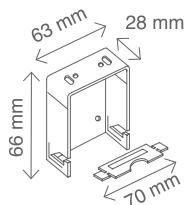

SCATOLA PER FISSAGGIO A PARETE O SOFFITTO (a richiesta)

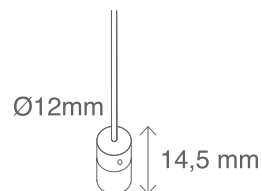

MORSETTONE IN ACCIAIO ZINCATO (fornito di serie)

N.B. Indicare la scelta desiderata nel modulo d'ordine.

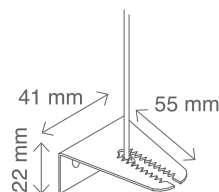

SQUADRETTA DI FISSAGGIO A PARETE CON MORSETTO (a richiesta)

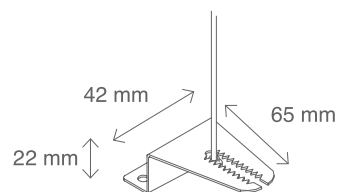

SQUADRETTA A Z CON MORSETTO (a richiesta)

ENEZIANA 50 MM IN LAMIERA

INGOMBRI DI SISTEMA

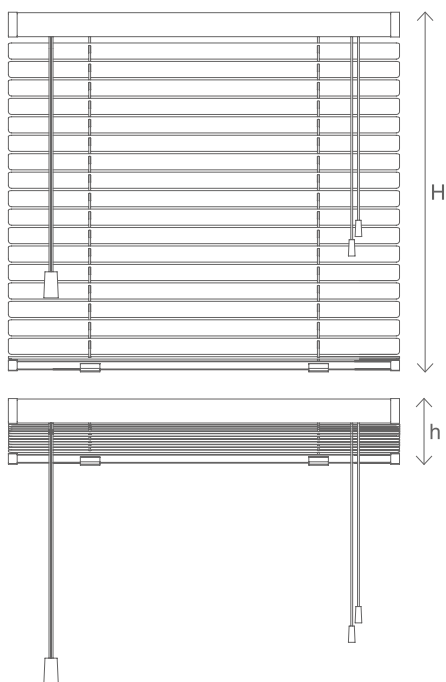

INGOMBRI *			
H mm	1000	2000	3000
h mm	100	125	150

*Ingombri indicativi

SUPPORTI				
Larghezza mm	< 1100	< 1900	< 3300	OLTRE
N° supporti	2	3	4	5

TIPI DI COMANDI

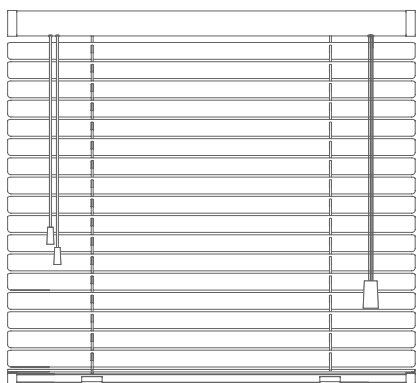

COMANDI E FATTIBILITÀ		
Da larghezza	A larghezza	Tipo di comando
300 mm	500 mm	Comandi standard
501 mm	3000 mm	Comandi standard / raggruppati

N.B. Misura massima in larghezza e altezza 3000mm.

Fornitura standard

IMPACCHETTAMENTO A DESTRA, ORIENTAMENTO A SINISTRA



Su richiesta
**IMPACCHETTAMENTO A SINISTRA,
ORIENTAMENTO A DESTRA**



Su richiesta
COMANDI A DESTRA

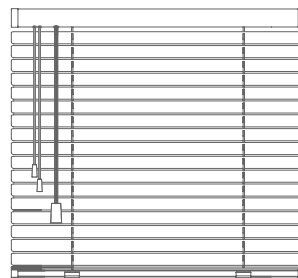

Su richiesta
COMANDI A SINISTRA

CARTELLA COLORI - 50 MM

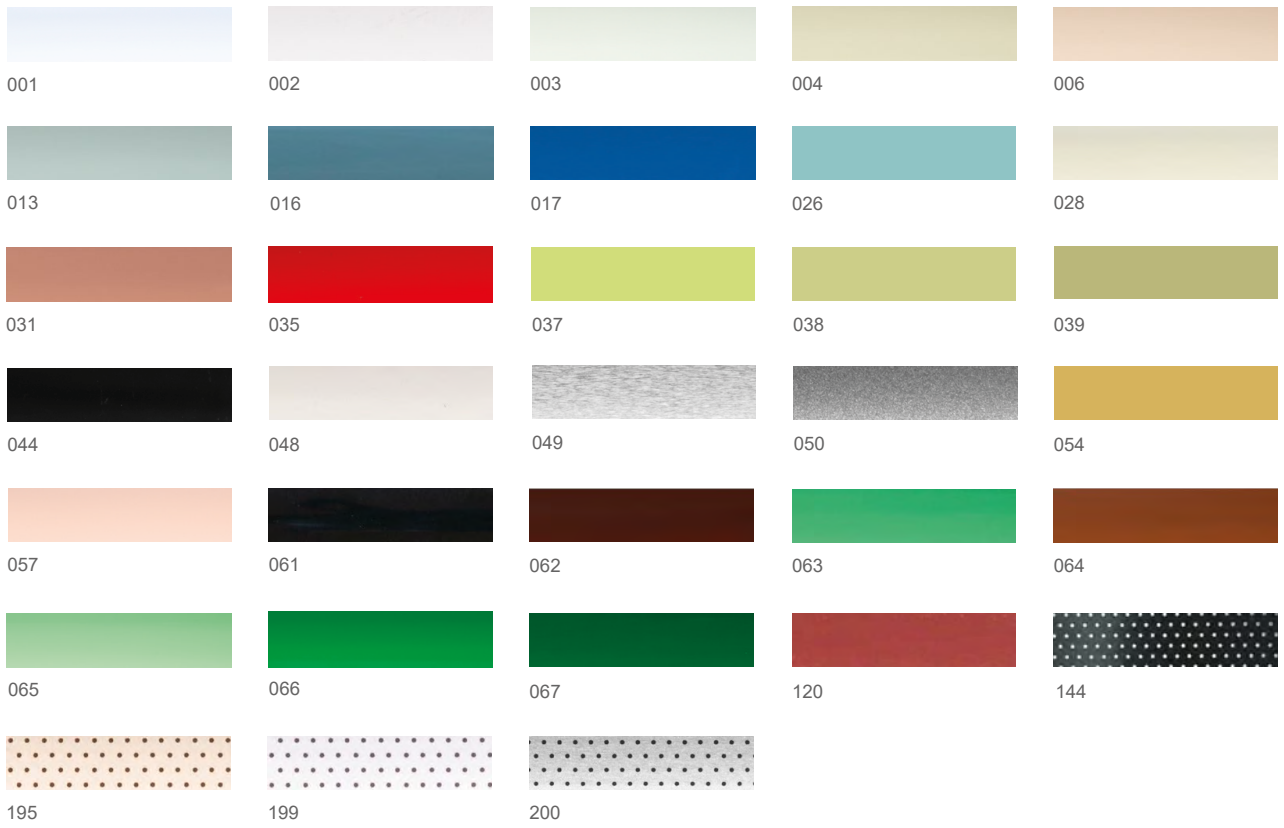

N.B. Per la scelta del colore desiderato consultare l'apposita CARTELLA COLORI.